



**Working together to promote  
*sustainable*  
water conservation**

Don Clark – CID, CLIA  
Senior Product Manager

---

The Intelligent Use of Water.™

**“At Rain Bird, we feel it is our responsibility to take the lead on water conservation by promoting it through not only efficient irrigation management, but also through education, training, and services for our industry and our communities. We call this **The Intelligent Use of Water™.**”**

Tony LeFetra, President

# The Rain Bird Legacy

- **75 years of industry innovation and leadership**
- **On leadership team of SWAT since its inception**
- **Largest industry contributor to SWAT**
- **Founding member of EPA's Steering Committee for Water Efficient Products**
- **Platinum sponsor for Alliance for Water Efficiency**
- **International Summits for IUOW for 10 years**
- **More than \$500,000 in contributions to the IA's contractor education initiatives**
- **100% of company is focused on landscape irrigation**

# Leaders in Water Efficient Technologies

- **Pressure regulating valves and stems**
- **Rain Curtain nozzle technology**
- **Sprinkler Check valves**
- **Full line of landscape drip irrigation**
- **Rotary nozzles**
- **ET Manager**
- **MaxiCom Central Control**

**.....More innovative water conserving products to  
come soon!!!**

# Water Purveyors Want a Smart Controller that:

- **Saves water**
- **Is simple to program**
- **Has no subscription fee**
- **Measures rainfall**
- **Is upgradeable on existing installations**
- **Optimizes the health and beauty of landscape**

# Introducing the Rain Bird ESP-SMT

## What is the ESP-SMT?

### “ESP” – Extra Simple Programming

Continues the legacy of the Rain Bird ESP family that customers have embraced due to its “ease of use” and high quality

*combined with*

### “SMT” – Smart Modular Technology

Utilizes proven scientific principles to automatically optimize the irrigation schedule in order to maintain healthy plant material



# *Rain Bird ESP-SMT*

## Smart Modular Irrigation Control System

*Two Key Components Make Up The ESP-SMT Smart Control System*

1. On-Site ESP-SMT Weather Sensor
2. ESP-SMT Modular Smart Controller



# Rain Bird ESP-SMT Controller Front Panel

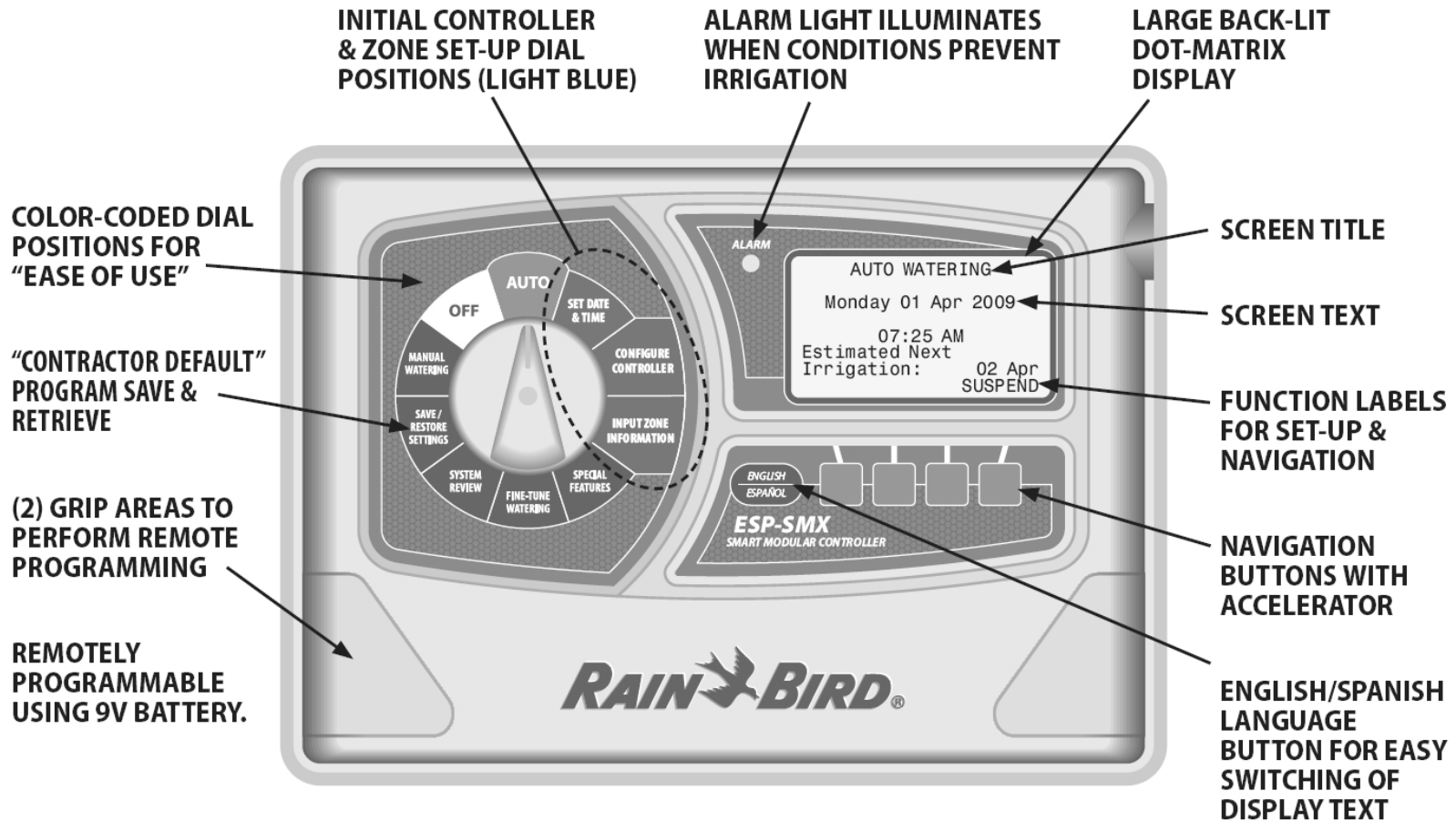

# Rain Bird ESP-SMT

## Weather Sensor & Mounting System

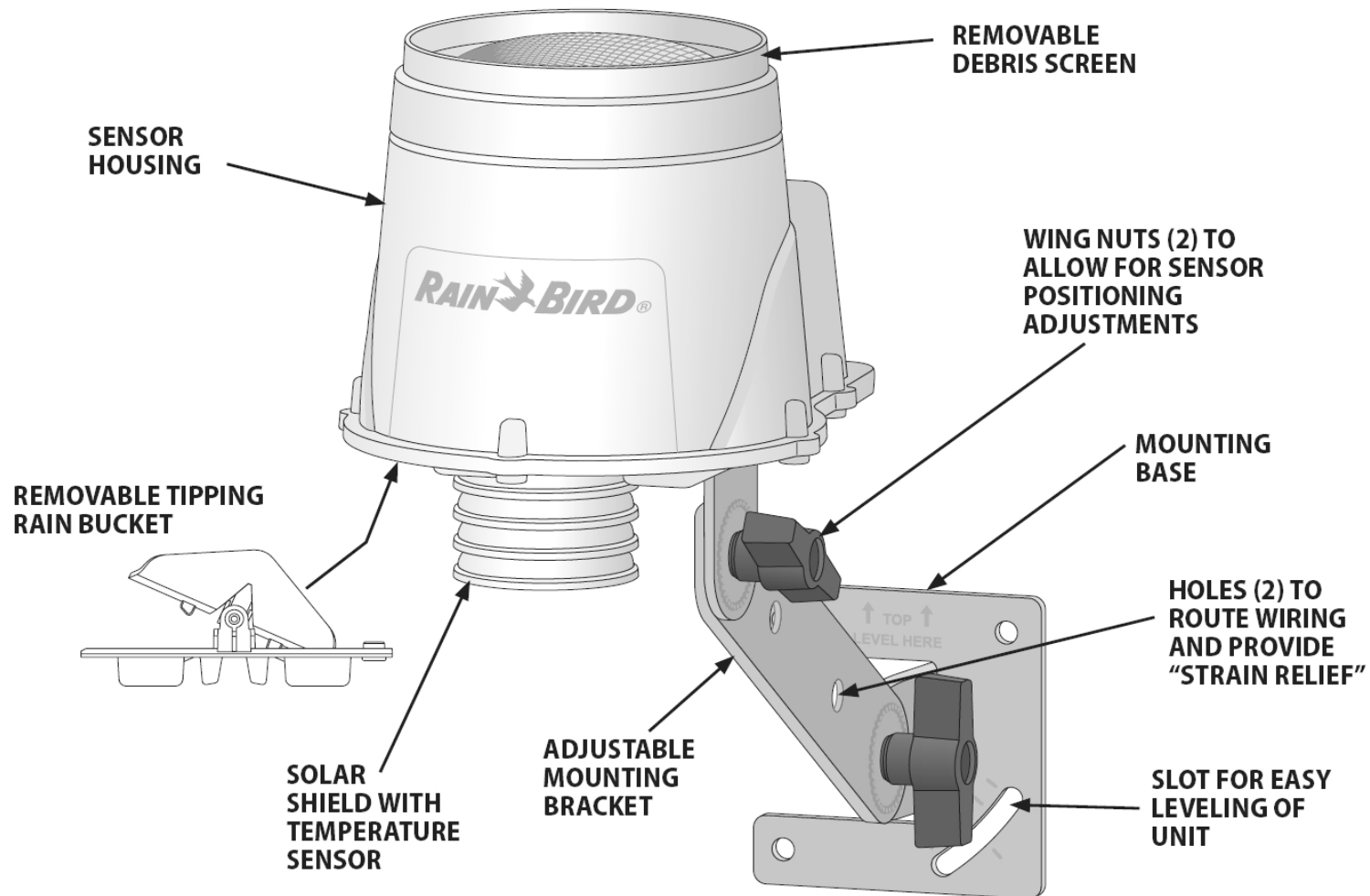

# *Rain Bird ESP-SMT*

## Smart Modular Irrigation Control System

### ESP-SMT Models

**ESP-SMT4i** – indoor controller & weather sensor - \$425

**ESP-SMT4** – outdoor controller & weather sensor - \$450

**ESP-SMT- UPG** – upgrade panel & weather sensor - \$325

\*

# Rain Bird ESP-SMT

## Smart Modular Control System

Learn how easy it is to use the ESP-SMT Smart Control System at [www.rainbird.com/ESP-SMT](http://www.rainbird.com/ESP-SMT)



Proving that extra smart can also be extra simple.

That's intelligent.

## Product Positioning

Proving that extra smart can also be extra simple.

That's Intelligent



Mounted in the weather sensor, the innovative tipping bucket measures rainfall to ensure proper irrigation scheduling.

Only the new Rain Bird® ESP-SMT Smart Control System combines the ease of Extra Simple Programming (ESP) with the accuracy of weather-based scheduling. Simply follow the prompts, input a few details about your site and programming is done. Then the weather-based control takes over, watering the precise amount you need, exactly where and when you need it. A smart controller that truly saves time, money and water. Now that's The Intelligent Use of Water.™

The Rain Bird logo, featuring the words "RAIN" and "BIRD" in a bold, green, sans-serif font, with a stylized green bird silhouette flying between them.

# *Rain Bird ESP-SMT*

## Smart Modular Control System



Proving that extra smart  
can also be extra simple.

That's intelligent.

### *Extra Smart*

- Schedule Optimizing
- Automatic Cycle & Soak
- Rain Suspend & Measurement Accounts for Effective Rainfall
- SWAT Test Scores
  - Adequacy = 100%
  - Scheduling Efficiency = 98.5%

### *Extra Simple*

- *Configure Controller and Zone Set-Up* Programming Wizards
- Self-prompting Programming
- HELP Screens
- English/Spanish Screen Text
- Field Test “Ease of Use” Survey Scores = 4.7+ out of 5.0

# ESP-SMT Field Test Results

## ESP-SMT vs. Competitive “Smart” Models\*

Manufacturer	Score
Rain Bird ESP-SMT Control System	4.54
Weathermatic Smartline with Weather Sensor	2.97
Hunter ET System	3.00
Irritrol Smart Dial, Toro Intellisense, HydroPoint Weathertrak	3.46

\* Based on Rain Bird ESP-SMT Field Test Survey Results (Oct,2008 to Mar, 2009 - Survey respondents who indicated they had experience with other manufacturers smart controllers using a school grading/scoring system: A = 5.0, B = 4.0, C = 3.0, D = 2.0, F = 1.0

- Most participants found the ESP-SMT controller to be
  - Extremely easy to install, program, set up, and operate
  - Of extremely high quality, especially the sensor mounting mechanism

# Working Together: The Tools for Success Program

- Program objective
  - Reduce water use by maximizing landscape water efficiency
- To accomplish this, EBMUD, Contractors, and Rain Bird must work together
  - Combine and leverage the strengths of each stakeholder
    - EBMUD incentive programs and customer relationships
    - Contractor relationships with end-users
    - Rain Bird relationships with Contractors
  - Surround the end-user with effective, consistent communications
  - Provide EBMUD and Contractors with professionally developed tools to accomplish the objective

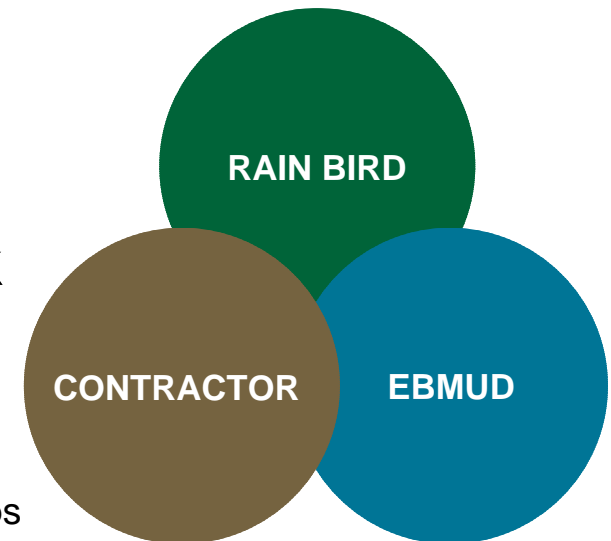

# Tools for Success: How It Works for EBMUD

- Provide EBMUD with highly targeted Smart Controller communication materials
  - Targeted and versioned for Contractors and Homeowners
  - Professionally designed and fully customizable to meet EBMUD's specific needs
    - Files for all materials are included on a leave-behind CD
    - You may customize yourself, as needed, or customization can be arranged by Rain Bird
  - EBMUD-branded (not Rain Bird branded); does not promote one product brand or manufacturer over another
  - All materials highlight available rebates and incentives as the primary call-to-action, which are key to category consideration and adoption

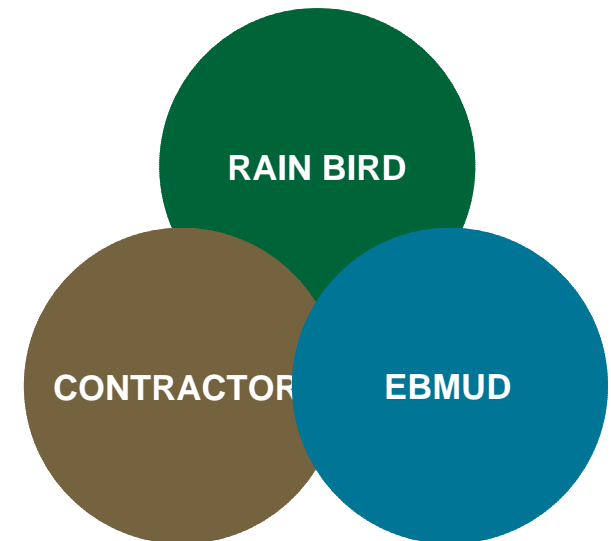

# Tools for Success: How It Works for EBMUD

- Rain Bird-provided Smart Controller materials include
  - Category overview brochure
  - Direct mail
  - Statement stuffers
  - Web landing pages



Residential Statement Stuffer



Contractor Brochure

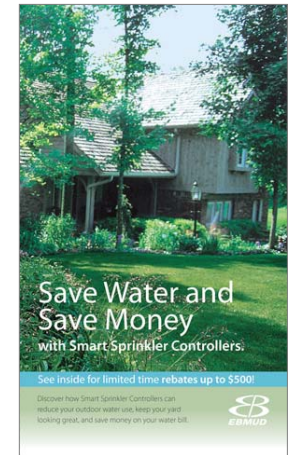

Residential Brochure



Contractor Web Landing Page



Residential Web Landing Page



Contractor Direct Mail

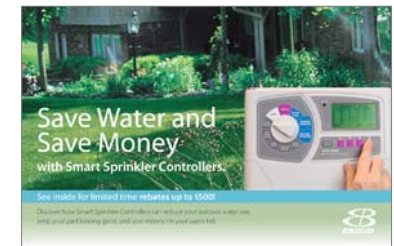

Residential Direct Mail

# Tools for Success: How It Works for Contractors

- EBMUD provides professionally designed communication materials
  - ET Controller category overview brochure
    - Used by Contractors
    - Versioned for Homeowners
    - Customized to EBMUD's programs and region
  - Direct mail to Contractors
    - Second version targeted to homeowners
  - EBMUD-branded (not Rain Bird branded); does not promote one product brand or manufacturer over another
  - All materials highlight available rebates and incentives as the primary call-to-action, which are key to category consideration and adoption

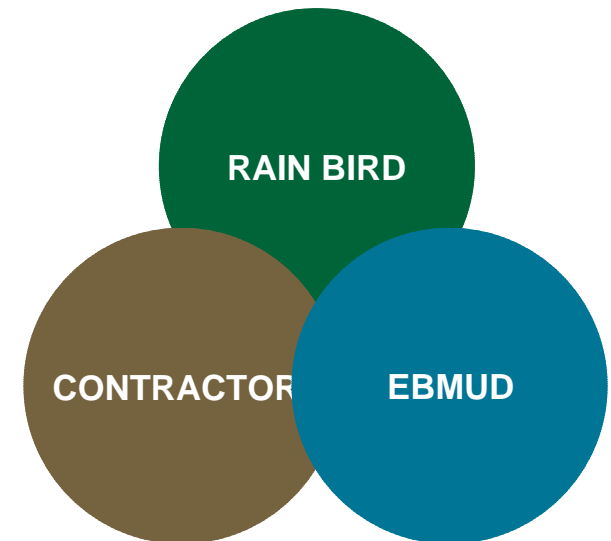

# Tools for Success: Grow Smart Events

- **Series of in-person sales training seminars for Contractors throughout EBMUD's service area**
  - Separate and distinct from Rain Bird's product-specific training
- **Teaches landscape and irrigation Contractors how to capitalize on the concept of water efficiency as a means to differentiate and grow their business**
- **Educates Contractors about the end-user benefits of water efficiency and the products that support the category, including Smart Controllers**
- **EBMUD encouraged to attend and participate**
  - Promote your programs, rebates and incentives
  - Develop relationships with Contractors
  - Demonstrate the District's commitment to and support of water efficiency

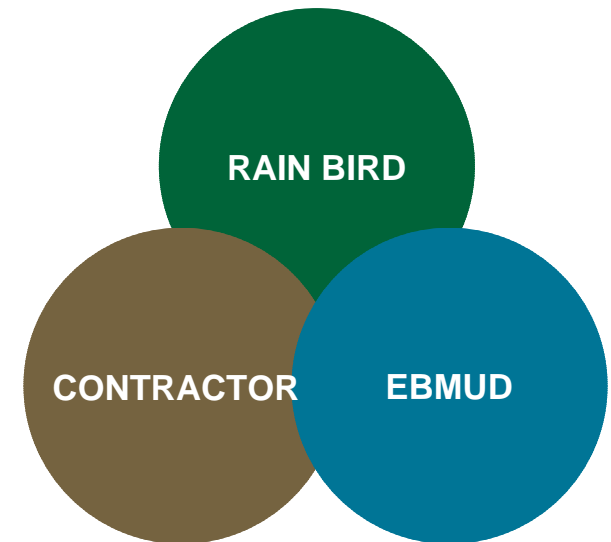

# Getting Started

Rain Bird is ready, willing and looking forward to working with you in any way we can to support outdoor water efficiency and help you reach your conservation goals

What you can do:

- **Use the customizable materials we have developed to promote Smart Controllers and your available incentives**
- **Include the Rain Bird ESP-SMT in your list of Smart Controller products that qualify for rebates and incentives**
- **Partner with Rain Bird to include the ESP-SMT in any upcoming product trials and/or direct buys**
- **Let us know what additional assistance we can provide to help you promote water efficiency**

# *Rain Bird ESP-SMT* Smart Modular Control System



**Thanks for your time!**

***Questions ???***